



冰箱连接器系列
Refrigerator Connector Series

250 (6.3) 系列

250 (6.3) SERIES

	型号 Part No.	适用电线范围 Wire Range		材料 Material	尺寸(mm) Size			插片 Tab	材料厚度 Material Thickness	包装数量 Q'ty/reel	备注 Note
		mm ²	AWG#		W	L	E				
	TP25021A-2	0.50~0.75	20-18	黄铜 Brass	7.5	17.2	7.8	6.3*0.8	0.4	6000PCS	
TP25022A-2	1.50~2.50	16-14	黄铜 Brass	7.5	17.2	7.8	6.3*0.8	0.4	6000PCS		

	型号 Part No.	适用电线范围 Wire Range		材料 Material	尺寸(mm) Size			插片 Tab	材料厚度 Material Thickness	包装数量 Q'ty/reel	备注 Note
		mm ²	AWG#		W	L	E				
	TP25011K-2	0.50~0.75	20-18	黄铜 Brass	7.6	19.3	7.8	6.3*0.8	0.4	7000PCS	
TP25012K-2	1.50~2.50	16-14	黄铜 Brass	7.6	19.0	7.7	6.3*0.8	0.4	6000PCS		

接地端子系列

*** terminal series



环形接地端子系列

***SERIES

	型号 Part No.	适用电线范围 Wire Range		材料 Material	尺寸(mm) Size			插片 Tab	材料厚度 Material Thickness	包装数量 Q'ty/reel	备注 Note
		mm ²	AWG#		W	L	E				
	TP25021A-2	0.50~0.75	20-18	黄铜 Brass	7.5	17.2	7.8	6.3*0.8	0.4	6000PCS	
	TP25022A-2	1.50~2.50	16-14	黄铜 Brass	7.5	17.2	7.8	6.3*0.8	0.4	6000PCS	

	型号 Part No.	适用电线范围 Wire Range		材料 Material	尺寸(mm) Size			插片 Tab	材料厚度 Material Thickness	包装数量 Q'ty/reel	备注 Note
		mm ²	AWG#		W	L	E				
	TP25011K-2	0.50~0.75	20-18	黄铜 Brass	7.6	19.3	7.8	6.3*0.8	0.4	7000PCS	
	TP25012K-2	1.50~2.50	16-14	黄铜 Brass	7.6	19.0	7.7	6.3*0.8	0.4	6000PCS	

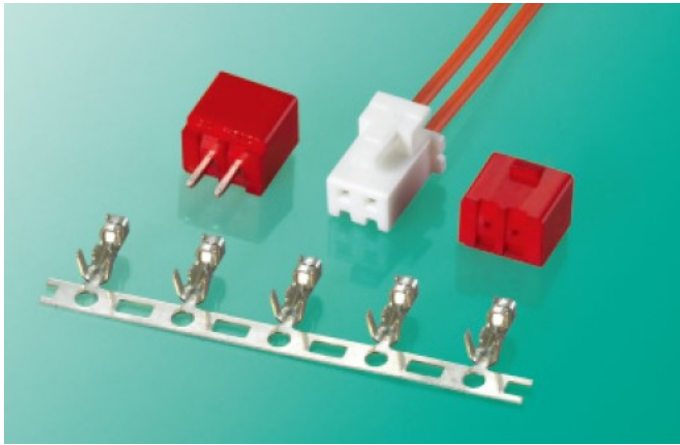

主要技术参数 (Main specifications)

- 额定电压 (Rating Voltage): 250V AC/DC
- 额定电流 (Rating Current): 3A
- 接触电阻 (Contact Resistance): $\leq 10\text{m}\Omega$
- 绝缘电阻 (Insulation Resistance): $\geq 1000\text{M}\Omega$
- 耐压 (Withstand Voltage): 1000V AC/1min.
- 温度范围 (Temperature Range): $-40^{\circ}\text{C}\sim 105^{\circ}\text{C}$
- 基板厚度 (PC Board Thickness): 1.6mm
- 孔座材料 (Housing Material): PA66
- 针座材料 (Wafer Material): PA66
- 端子材料 (Terminal Material): 磷青铜 Phosphor Bronze

◆ TERMINAL

	适用电线范围 Wire Range		包装数量 Q'ty/reel	备注 Note
	型号 Part No.	mm ²		
	TP2502J-3(A)	0.15	26	6000PCS
	TP2502J-3	0.20~0.30	24-22	6000PCS
	TP2502J-3(C)	0.50	20	6000PCS

◆ HOUSING

	孔位 Circuits	规格型号 Part No.	尺寸(mm) Size	
			A	B
	2	HP2502J-B-2Y	2.5	5.8
	3	HP2502J-B-3Y	5.0	8.3
	4	HP2502J-B-4Y	7.5	10.8
	5	HP2502J-B-5Y	10.0	13.3
	6	HP2502J-B-6Y	12.5	15.8
	7	HP2502J-B-7Y	15.0	18.3
	8	HP2502J-B-8Y	17.5	20.8
	9	HP2502J-B-9Y	20.0	23.3
	10	HP2502J-B-10Y	22.5	25.8
	11	HP2502J-B-11Y	25.0	28.3
	12	HP2502J-B-12Y	27.5	30.8
	13	HP2502J-B-13Y	30.0	33.3
	14	HP2502J-B-14Y	32.5	35.8
	15	HP2502J-B-15Y	35.0	38.3

XH 系列(2.5mm 间距)
XH SERIES(2.5mm PITCH)



◆ WAFER

孔位 Circuits	规格型号 Part No.	尺寸(mm) Size	
		A	B
2	HW2502J-B-2A	2.5	7.5
3	HW2502J-B-3A	5.0	10.0
4	HW2502J-B-4A	7.5	12.5
5	HW2502J-B-5A	10.0	15.0
6	HW2502J-B-6A	12.5	17.5
7	HW2502J-B-7A	15.0	20.0
8	HW2502J-B-8A	17.5	22.5
9	HW2502J-B-9A	20.0	25.0
10	HW2502J-B-10A	22.5	27.5
11	HW2502J-B-11A	25.0	30.0
12	HW2502J-B-12A	27.5	32.5
13	HW2502J-B-13A	30.0	35.0
14	HW2502J-B-14A	32.5	37.5
15	HW2502J-B-15A	35.0	40.0

◆ RETAINER

孔位 Circuits	规格型号 Part No.	尺寸(mm) Size	
		A	B
2	HC2502J-2S	2.5	9.9
3	HC2502J-3S	5.0	12.4
4	HC2502J-4S	7.5	13.4
5	HC2502J-5S	10.0	15.9
6	HC2502J-6S	12.5	18.4
7	HC2502J-7S	15.0	20.9
8	HC2502J-8S	17.5	23.4
9	HC2502J-9S	20.0	25.9
10	HC2502J-10S	22.5	28.4
11	HC2502J-11S	25.0	30.9
12	HC2502J-12S	27.5	33.4
13	HC2502J-13S	30.0	35.9
14	HC2502J-14S	32.5	38.4
15	HC2502J-15S	35.0	40.9

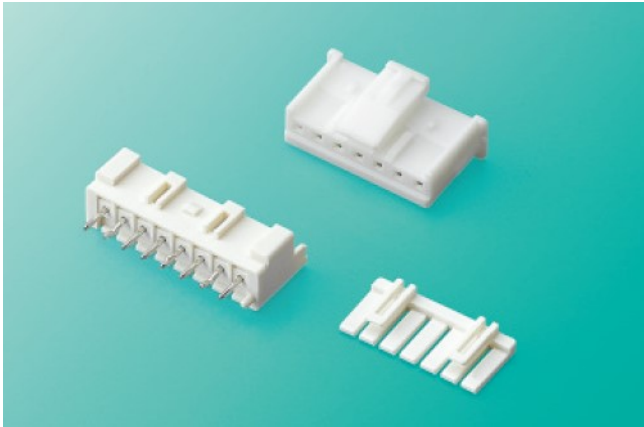

主要技术参数 (Main specifications)

- 额定电压 (Rating Voltage): 250V AC/DC
- 额定电流 (Rating Current): 3A
- 接触电阻 (Contact Resistance): $\leq 10\text{m}\Omega$
- 绝缘电阻 (Insulation Resistance): $\geq 1000\text{M}\Omega$
- 耐 压 (Withstand Voltage): 1000V AC/1min.
- 温度范围 (Temperature Range): $-40^{\circ}\text{C}\sim 105^{\circ}\text{C}$
- 基板厚度 (PC Board Thickness): 1.6mm
- 孔座材料 (Housing Material): PA66
- 针座材料 (Wafer Material): PA66
- 端子材料 (Terminal Material): 磷青铜 Phosphor Bronze

◆ TERMINAL

	型号 Part No.	适用电线范围 Wire Range		包装数量 Q'ty/reel	备注 Note
		mm ²	AWG#		
	TP2503J-3	0.15~0.30	26-22	8000PCS	

孔位 Circuits	规格型号 Part No.	尺寸(mm) Size		
		A	B	C
2	HP2503J-2Y	2.5	5.6	7.3
3	HP2503J-3Y	5.0	8.1	9.8
4	HP2503J-4Y	7.5	10.6	12.3
5	HP2503J-5Y	10.0	13.1	14.8
6	HP2503J-6Y	12.5	15.6	17.3
7	HP2503J-7Y	15.0	18.1	19.8
8	HP2503J-8Y	17.5	20.6	22.3
9	HP2503J-9Y	20.0	23.1	24.8
10	HP2503J-10Y	22.5	25.6	27.3
11	HP2503J-11Y	25.0	28.1	29.8
12	HP2503J-12Y	27.5	30.6	32.3
13	HP2503J-13Y	30.0	33.1	34.8
14	HP2503J-14Y	32.5	35.6	37.3
15	HP2503J-15Y	35.0	38.1	39.8

	16	HP2503J-16Y	37.5	40.6	42.3
--	----	-------------	------	------	------

◆ HOUSING

XA 系列(2.5mm 间距)

XA SERIES(2.5mm PITCH)



◆ WAFER

HW2503J-nA	孔位 Circuits	规格型号 Part No.		尺寸(mm) Size	
				A	B
			2	HW2503J-2A	HW2503J-D-2A
	3	HW2503J-3A	HW2503J-D-3A	5.0	10.0
	4	HW2503J-4A	HW2503J-D-4A	7.5	12.5
	5	HW2503J-5A	HW2503J-D-5A	10.0	15.0
	6	HW2503J-6A	HW2503J-D-6A	12.5	17.5
	7	HW2503J-7A	HW2503J-D-7A	15.0	20.0
HW2503J-D-nA	8	HW2503J-8A	HW2503J-D-8A	17.5	22.5
	9	HW2503J-9A	HW2503J-D-9A	20.0	25.0
	10	HW2503J-10A	HW2503J-D-10A	22.5	27.5
	11	HW2503J-11A	HW2503J-D-11A	25.0	30.0
	12	HW2503J-12A	HW2503J-D-12A	27.5	32.5
	13	HW2503J-13A	HW2503J-D-13A	30.0	35.0
	14	HW2503J-14A	HW2503J-D-14A	32.5	37.5
	15	HW2503J-15A	HW2503J-D-15A	35.0	40.0
	16	HW2503J-16A	HW2503J-D-16A	37.5	42.5

◆ RETAINER

	孔位 Circuits	规格型号 Part No.		尺寸(mm) Size	
				A	B
			2	HC2503J-2S	2.5
	3	HC2503J-3S	5.0	6.9	
	4	HC2503J-4S	7.5	9.4	
	5	HC2503J-5S	10.0	11.9	
	6	HC2503J-6S	12.5	14.4	
	7	HC2503J-7S	15.0	16.9	
	8	HC2503J-8S	17.5	19.4	
	9	HC2503J-9S	20.0	21.9	
	10	HC2503J-10S	22.5	24.4	
	11	HC2503J-11S	25.0	26.9	
	12	HC2503J-12S	27.5	29.4	
	13	HC2503J-13S	30.0	31.9	
	14	HC2503J-14S	32.5	34.4	
	15	HC2503J-15S	35.0	36.9	
	16	HC2503J-15S	37.5	39.4	

HC3502J-2x2S

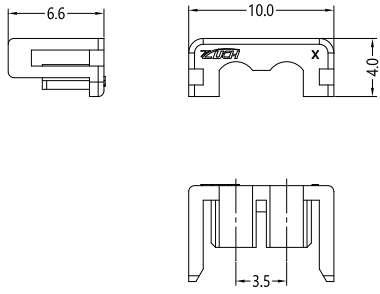

HC3502J-2x3S

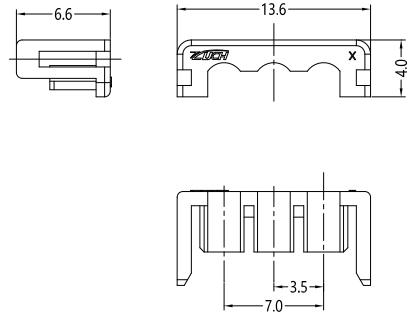

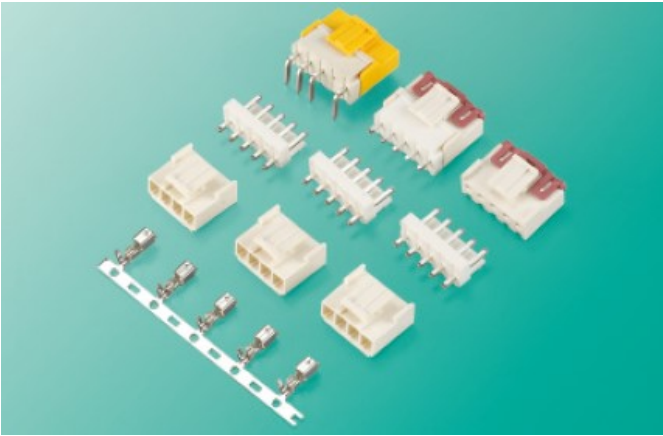

主要技术参数 (Main specifications)

- 额定电压 (Rating Voltage): 250V AC/DC
- 额定电流 (Rating Current): 7A
- 接触电阻 (Contact Resistance): $\leq 10\text{m}\Omega$
- 绝缘电阻 (Insulation Resistance): $\geq 1000\text{M}\Omega$
- 耐压 (Withstand Voltage): 1500V AC/1min.
- 温度范围 (Temperature Range): $-40^{\circ}\text{C}\sim 105^{\circ}\text{C}$
- 基板厚度 (PC Board Thickness): 1.6mm
- 孔座材料 (Housing Material): PA66
- 针座材料 (Wafer Material): PA66
- 端子材料 (Terminal Material): 磷青铜 Phosphor Bronze

◆ TERMINAL

型号 Part No.	适用电线范围 Wire Range		包装数量 Q'ty/reel	备注 Note
	mm ²	AWG#		
TP3960J-3(D)	0.30	22	3000PCS	
TP3960J-3	0.50~0.75	20-18	3000PCS	
TP3960J-3(G)	0.75~1.50	18-16	3000PCS	

◆ HOUSING

孔位 Circuits	规格型号 Part No.	尺寸(mm) Size	
		A	B
2	HP3960J-2Y	3.96	8.3
3	HP3960J-3Y	7.92	12.26
4	HP3960J-4Y	11.88	16.22
5	HP3960J-5Y	15.84	20.18
6	HP3960J-6Y	19.80	24.14
7	HP3960J-7Y	23.76	28.1
8	HP3960J-8Y	27.72	32.06
9	HP3960J-9Y	31.68	36.02
10	HP3960J-10Y	35.64	39.98
11	HP3960J-11Y	39.60	43.94
12	HP3960J-12Y	43.56	47.9

VH 系列(3.96mm 间距)
VH SERIES(3.96mm PITCH)



◆ WAFER

HW3960J-nA			孔位 Circuits	规格型号 Part No.			尺寸(mm) Size	
							A	B
				2	HW3960J-2A	HW3960J-D-2A	HW3960J-2QA	3.96
3	HW3960J-3A	HW3960J-D-3A	HW3960J-3QA	7.92	11.88			
4	HW3960J-4A	HW3960J-D-4A	HW3960J-4QA	11.88	15.84			
5	HW3960J-5A	HW3960J-D-5A	HW3960J-5QA	15.84	19.80			
6	HW3960J-6A	HW3960J-D-6A	HW3960J-6QA	19.80	23.76			
7	HW3960J-7A	HW3960J-D-7A	HW3960J-7QA	23.76	27.72			
8	HW3960J-8A	HW3960J-D-8A	HW3960J-8QA	27.72	31.68			
9	HW3960J-9A	HW3960J-D-9A	HW3960J-9QA	31.68	35.64			
10	HW3960J-10A	HW3960J-D-10A	HW3960J-10QA	35.64	39.60			
11	HW3960J-11A	HW3960J-D-11A	HW3960J-11QA	39.60	43.56			
12	HW3960J-12A	HW3960J-D-12A	HW3960J-12QA	43.56	47.52			

HW3960M-nA			孔位 Circuits	规格型号 Part No.		尺寸(mm) Size	
						A	B
				5	HW3960M-5A	HW3960M-D-5A	15.84
6	HW3960M-6A	HW3960M-D-6A	19.80	25.69			
7	HW3960M-7A	HW3960M-D-7A	23.76	29.65			

	9	HW3960M-9A	HW3960M-D-9A	31.68	37.57
--	---	------------	--------------	-------	-------

VH 系列(3.96mm 间距)
VH SERIES(3.96mm PITCH)



◆ RETAINER

	孔位 Circuits	规格型号 Part No.	尺寸(mm) Size	
			A	B
	2	HC3960J-2S	3.96	7.0
	3	HC3965J-3S	7.92	11.02
	4	HC3965J-4S	11.88	15.80
	5	HC3965J-5S	15.84	18.95
	6	HC3965J-6S	19.80	22.9
	7	HC3965J-7S	23.76	26.86
	8	HC3965J-8S	27.72	30.82
	9	HC3965J-9S	31.68	34.78
	10	HC3965J-10S	35.64	38.74
	11	HC3965J-11S	39.60	42.7
	12	HC3965J-12S	43.56	46.66

3968 系列(3.96mm 间距)

3968 SERIES(3.96mm PITCH)



主要技术参数 (Main specifications)

- 额定电压 (Rating Voltage): 300V AC/DC
- 额定电流 (Rating Current): 10A
- 接触电阻 (Contact Resistance): $\leq 10\text{m}\Omega$
- 绝缘电阻 (Insulation Resistance): $\geq 1000\text{M}\Omega$
- 耐压 (Withstand Voltage): 1500V AC/1min.
- 温度范围 (Temperature Range): $-40^{\circ}\text{C}\sim 105^{\circ}\text{C}$
- 孔座材料 (Housing Material): PA66
- 插座材料 (Socket Material): PA66

◆ TERMINAL

	型号 Part No.	适用电线范围 Wire Range		材质 Material	包装数量 Q'ty/reel
		mm ²	AWG#		
	TP3968A-3(A)	0.2~0.30	24-22	磷青铜 PB	3500PCS
	TP3968A-3	0.50~0.75	20-18	磷青铜 PB	3500PCS

	型号 Part No.	适用电线范围 Wire Range		材质 Material	包装数量 Q'ty/reel
		mm ²	AWG#		
	TR3968A-3(A)	0.2~0.30	24-22	黄铜 Brass	3500PCS
	TR3968A-3	0.50~0.75	20-18	黄铜 Brass	3500PCS

◆ HOUSING

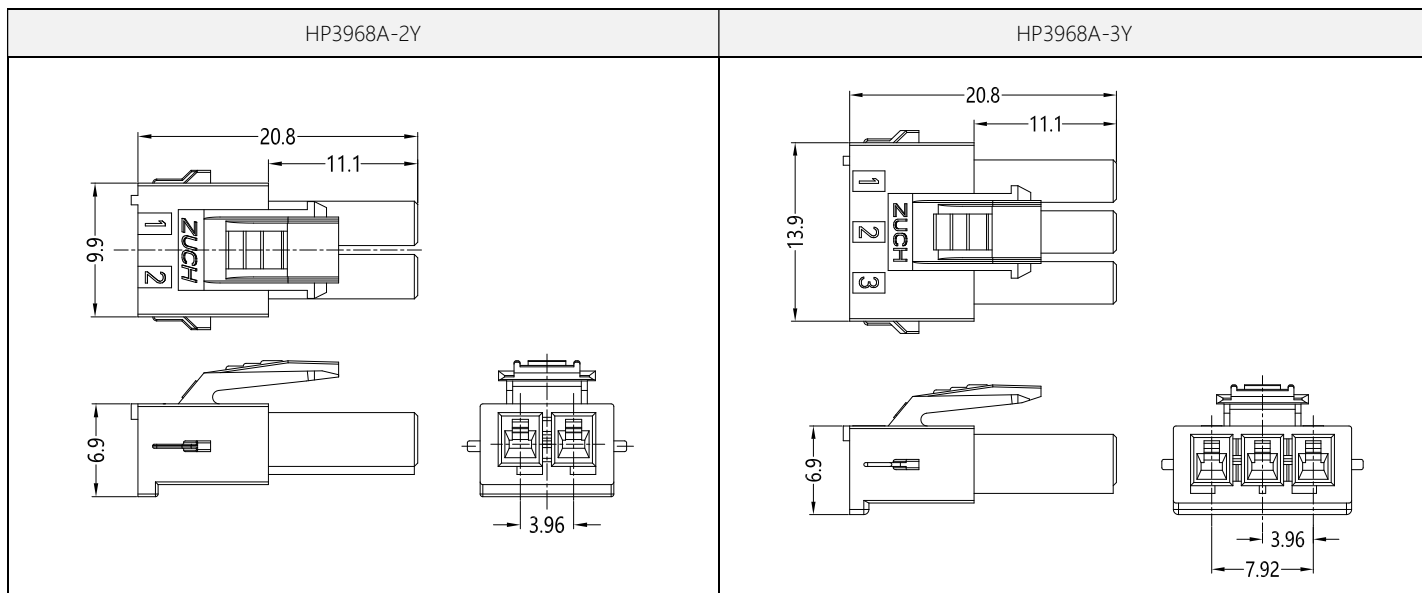

3968 系列(3.96mm 间距)

3968 SERIES(3.96mm PITCH)



◆ HOUSING

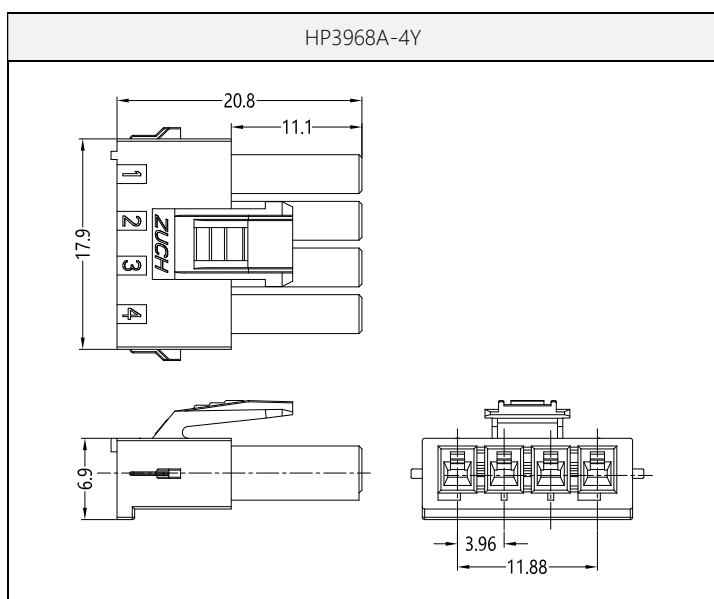

◆ SOCKET

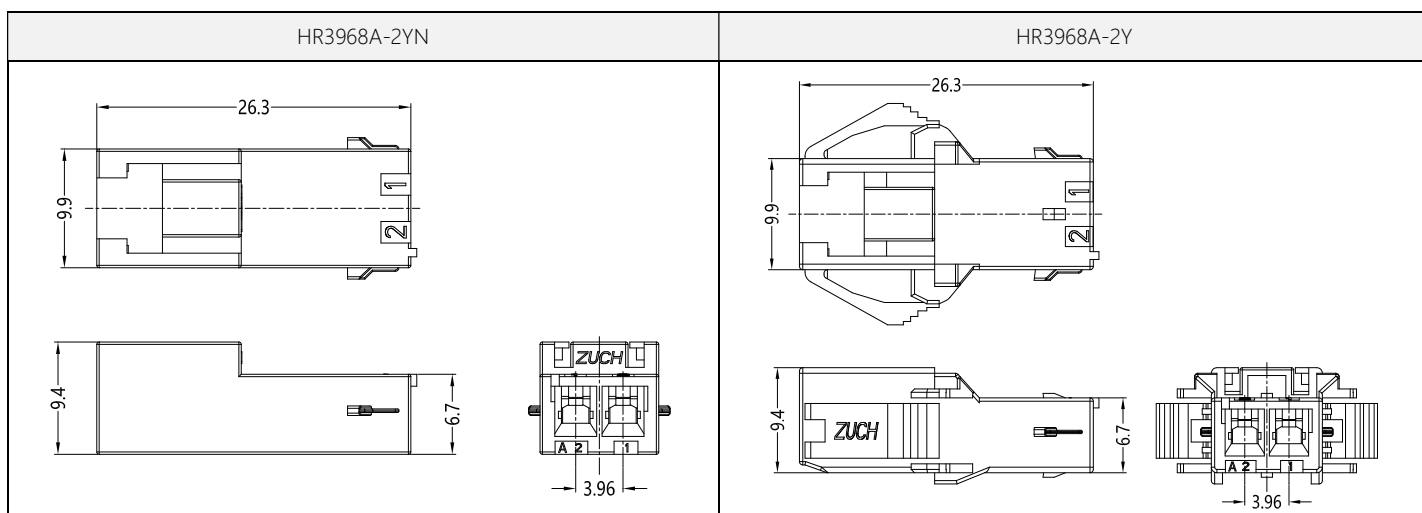

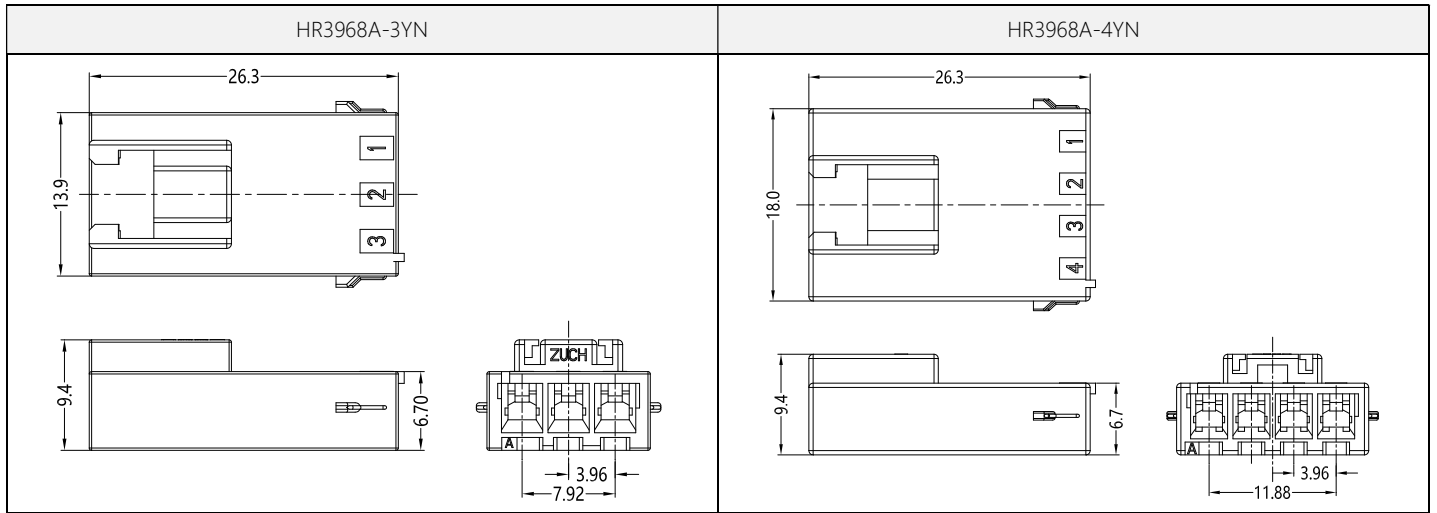

3968 系列(3.96mm 间距)
3968 SERIES(3.96mm PITCH)



◆ SOCKET

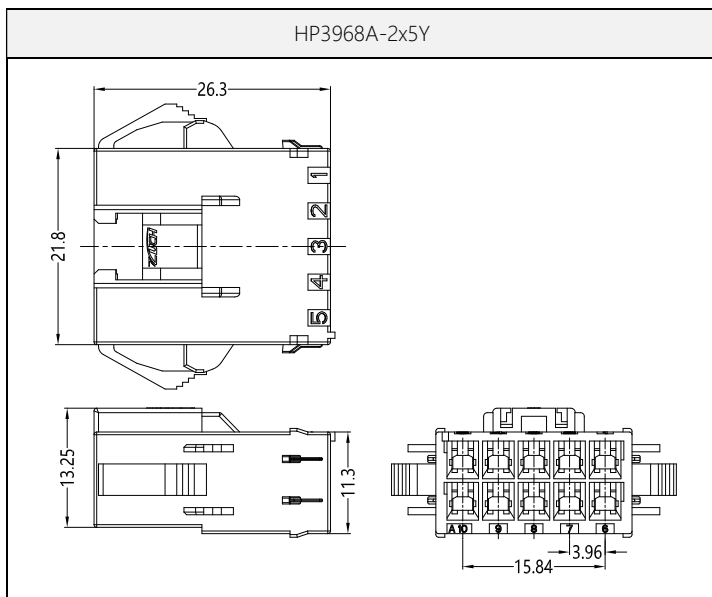

◆ RETAINER

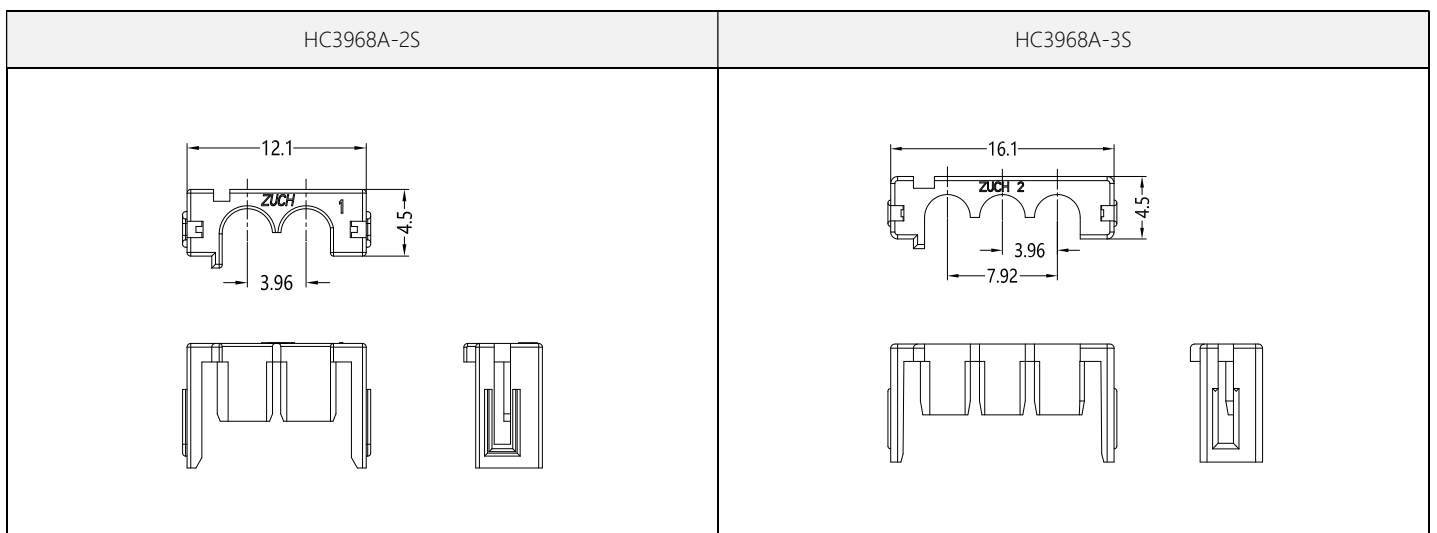

HC3968A-4S

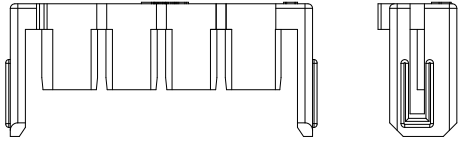
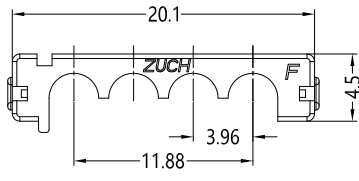

HC3968A-5S

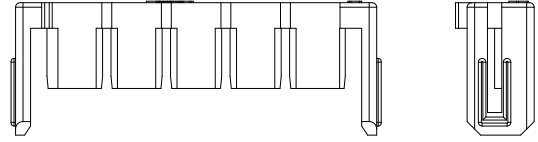
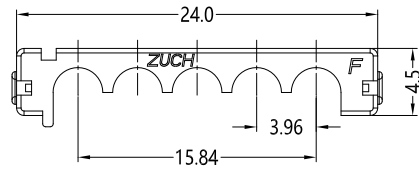

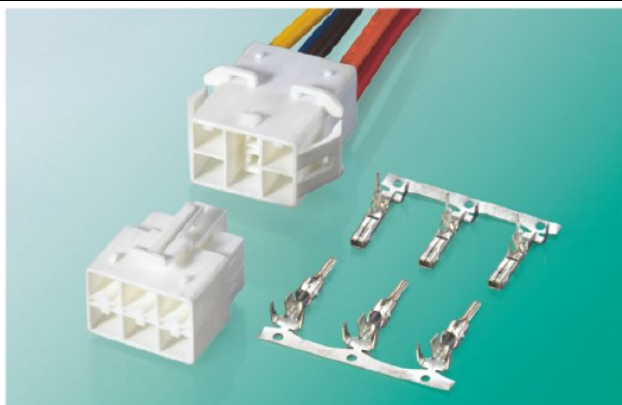

主要技术参数 (Main specifications)

- 额定电压 (Rating Voltage): 250V AC/DC
- 额定电流 (Rating Current): 12A
- 接触电阻 (Contact Resistance): $\leq 10\text{m}\Omega$
- 绝缘电阻 (Insulation Resistance): $\geq 1000\text{M}\Omega$
- 耐压 (Withstand Voltage): 1500V AC/1min.
- 温度范围 (Temperature Range): $-25^{\circ}\text{C}\sim 85^{\circ}\text{C}$
- 孔座材料 (Housing Material): PA66
- 插座材料 (Socket Material): PA66
- 端子材料 (Terminal Material): 黄铜 Brass

◆ TERMINAL

	型号 Part No.	适用电线范围 Wire Range		材质 Material	包装数量 Q'ty/reel
		mm ²	AWG#		
	TP1801M-3 (A) (35748-0110)	0.50~0.75	20-18	黄铜 Brass	3500PCS
	TP1801M-3 (B) (35748-0210)	1.50~2.50	16-14	黄铜 Brass	2500PCS
	TP1801M-3 (C) (35748-0310)	0.5+0.5 0.5+0.75 0.75+0.75	20+20 20+18 18+18	黄铜 Brass	2500PCS
TP1801M-3 (D) (35748-0410)	0.20~0.30	24-22	黄铜 Brass	3500PCS	

	型号 Part No.	适用电线范围 Wire Range		材质 Material	包装数量 Q'ty/reel
		mm ²	AWG#		
	TP1802M-3 (A) (35746-0110)	0.50~0.75	20-18	黄铜 Brass	3500PCS
	TP1802M-3 (B) (35746-0210)	1.50~2.50	16-14	黄铜 Brass	2500PCS
	TP1802M-3 (C) (35746-0310)	0.5+0.5 0.5+0.75 0.75+0.75	20+20 20+18 18+18	黄铜 Brass	2500PCS
TP1802M-3 (D) (35746-0410)	0.20~0.30	24-22	黄铜 Brass	3500PCS	

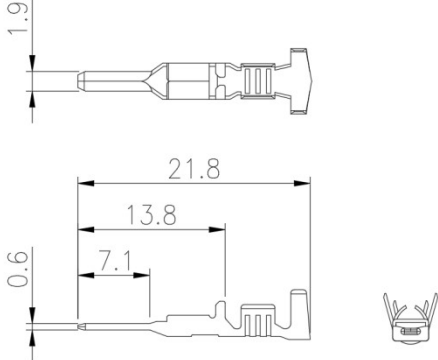
	型号 Part No.	适用电线范围 Wire Range		材质 Material	包装数量 Q'ty/reel
		mm ²	AWG#		
		TR1801M-3 (A) (35747-0110)	0.50~0.75		
TR1801M-3 (B) (35747-0210)	1.50~2.50	16-14	黄铜 Brass	2500PCS	
TR1801M-3 (C) (35747-0310)	0.5+0.5 0.5+0.75 0.75+0.75	20+20 20+18 18+18	黄铜 Brass	2500PCS	
TR1801M-3 (D) (35747-0410)	0.20~0.30	24-22	黄铜 Brass	3500PCS	

	型号 Part No.	适用电线范围 Wire Range		材质 Material	包装数量 Q'ty/reel
		mm ²	AWG#		
		TR1802M-3 (A) (35745-0110)	0.50~0.75		
TR1802M-3 (B) (35745-0210)	1.50~2.50	16-14	黄铜 Brass	2500PCS	
TR1802M-3 (C) (35745-0310)	0.5+0.5 0.5+0.75 0.75+0.75	20+20 20+18 18+18	黄铜 Brass	2500PCS	
TR1802M-3 (D) (35745-0410)	0.20~0.30	24-22	黄铜 Brass	3500PCS	

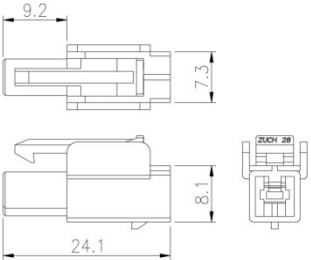
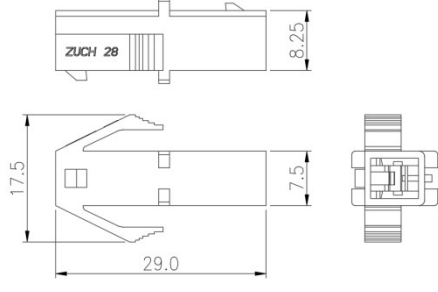
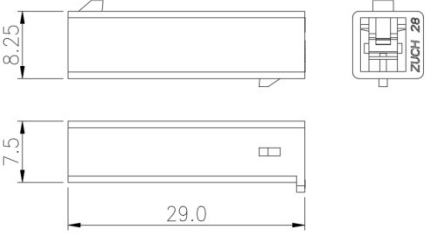
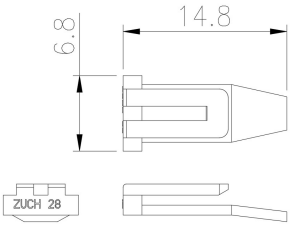
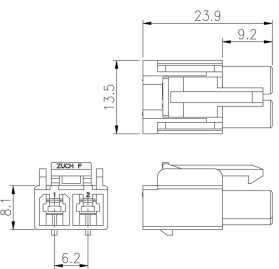
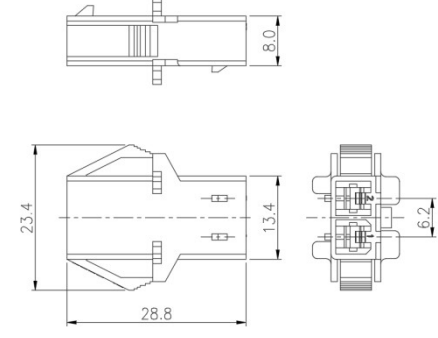
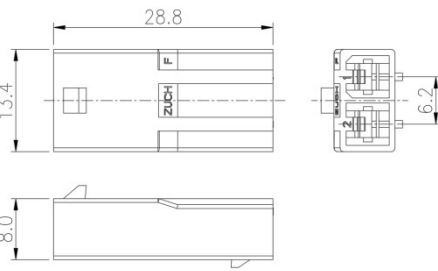
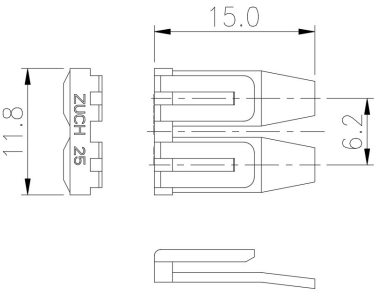
孔位 Circuits	◆ HOUSING	◆ SOCKET	◆ RETAINER
1	<p>HP1802M-1Y (35151-0110)</p>	<p>HR1802M-1Y (35150-0110)</p>	<p>HC1803M-1S (35182-0190)</p>
		 <p>HR1802M-1YN (35150-0100)</p> 	
2	<p>HP1802M-2Y (35151-0210)</p>	<p>HR1802M-2Y (35150-0210)</p>	<p>HC1802M-2S (35150-0290)</p>
		 <p>HR1802M-2YN (35150-0200)</p> 	

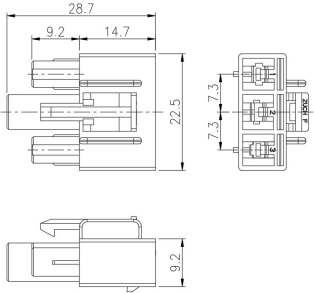
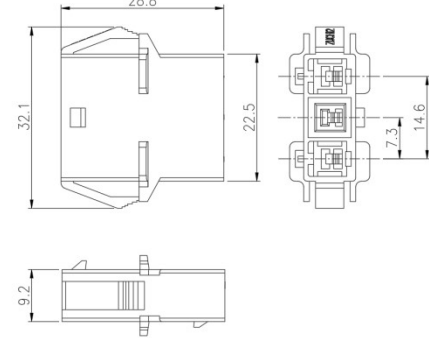
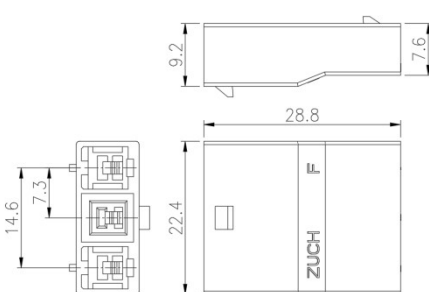
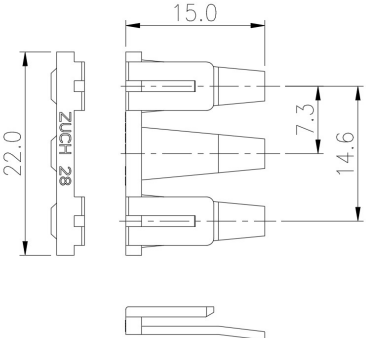
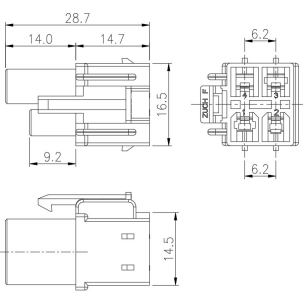
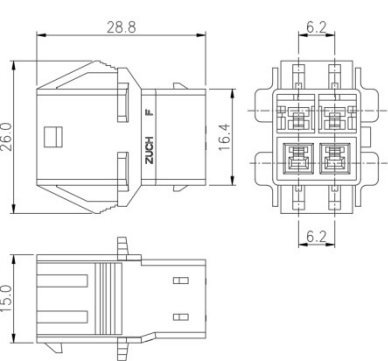
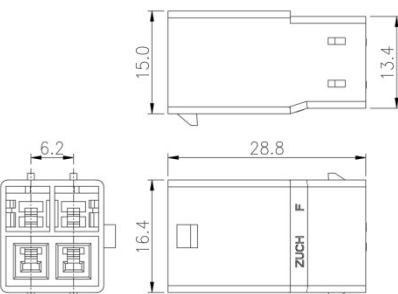
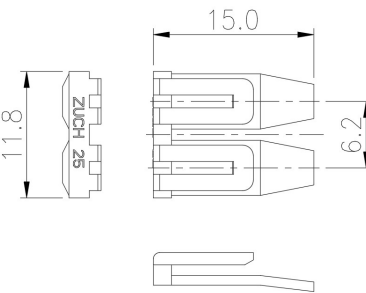
孔位 Circuits	◆ HOUSING	◆ SOCKET	◆ RETAINER
3	<p>HP1802M-3Y (35151-0310)</p>	<p>HR1802M-3Y (35150-0310)</p>	<p>HC1802M-3S (35150-0390)</p>
		 <p>HR1802M-3YN (35150-0300)</p> 	
4	<p>HP1802M-4Y (35151-0410)</p>	<p>HR1802M-4Y (35150-0410)</p>	<p>HC1802M-2S (35150-0290)</p>
		 <p>HR1802M-4YN (35150-0400)</p> 	

孔位 Circuits	◆ HOUSING	◆ SOCKET	◆ RETAINER
4	<p>HP18021M-2Y (35965-0210)</p>	<p>HR1803M-4Y (35160-0400)</p>	<p>HC1803M-2S (35182-0290)</p>
	<p>HP18022M-2Y (35965-0200)</p>		<p>HC18023M-2S (35965-0290)</p>
	<p>HP18031M-2Y (35181-0210)</p>		<p>HC1803M-2S (35182-0290)</p>
4	<p>HP18032M-2Y (35181-0200)</p>	<p>HR1803M-4Y (35160-0400)</p>	<p>HC1803M-1S (35182-0190)</p>

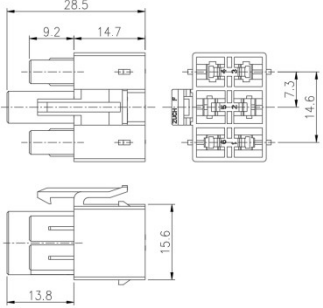
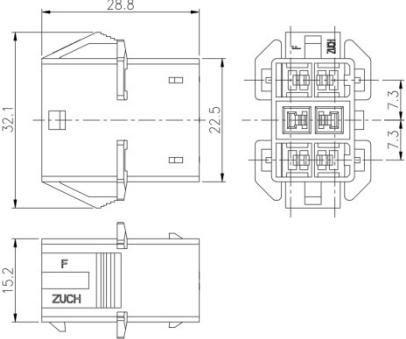
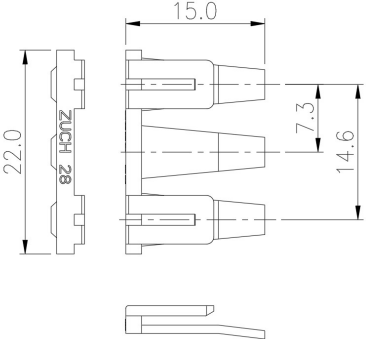
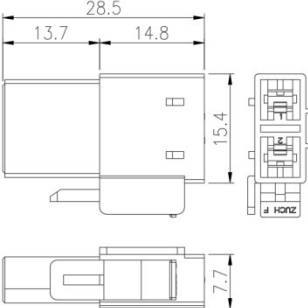
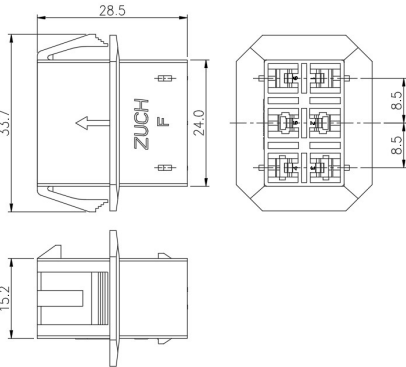
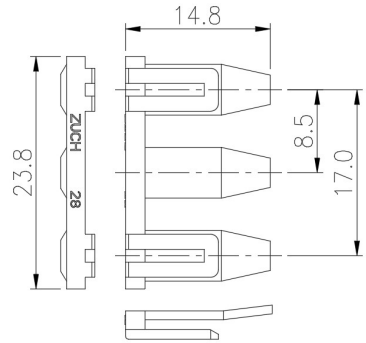
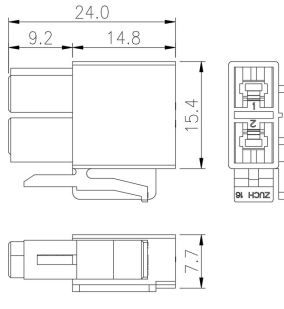
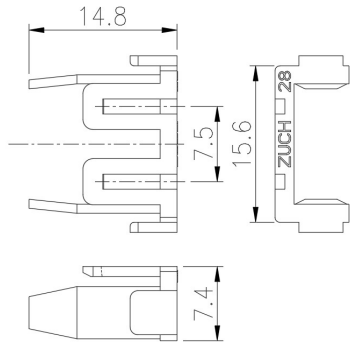
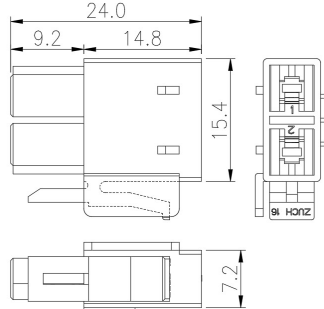
孔位 Circuits	◆ HOUSING	◆ SOCKET	◆ RETAINER
6	<p>HP1802M-6Y (35151-0610)</p>	<p>HR1802M-6Y (35150-0610)</p>	<p>HC1802M-3S (35150-0390)</p>
			
6	<p>HP18021M-2Y (35965-0210)</p>	<p>HR1803M-6Y (35180-0600)</p>	<p>HC1803M-3S (35182-0390)</p>
			
	<p>HP18022M-2Y (35965-0200)</p>		
			
<p>HP18023M-2Y (35965-0220)</p> 			

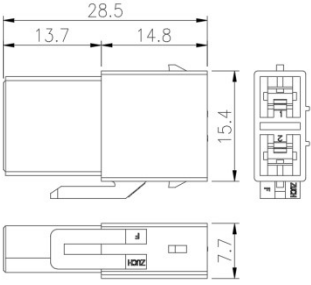
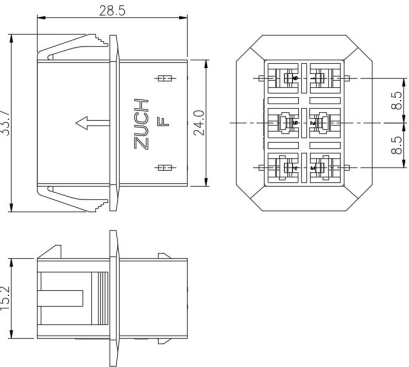
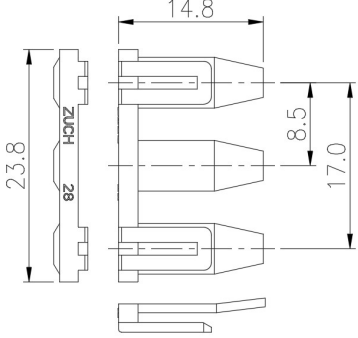
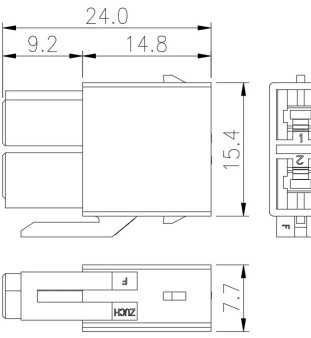
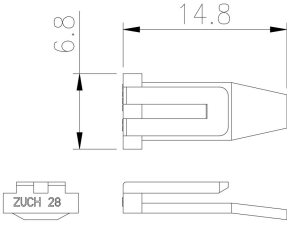
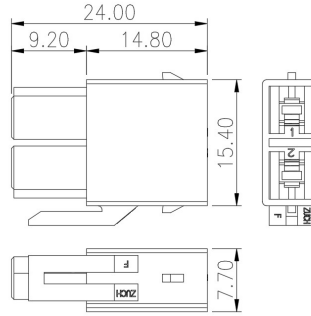
孔位 Circuits	◆ HOUSING	◆ SOCKET	◆ RETAINER
6	HP18031M-2Y (35181-0210)	HR1803M-6Y (35180-0600)	HC1803M-3S (35182-0390)
			
	HP18032M-2Y (35181-0200)		HC1803M-1S (35182-0190)
			
	HP18033M-2Y (35181-0220)		
			

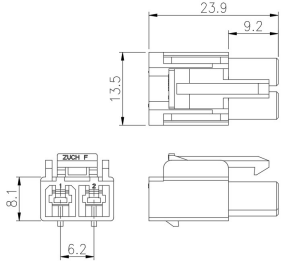
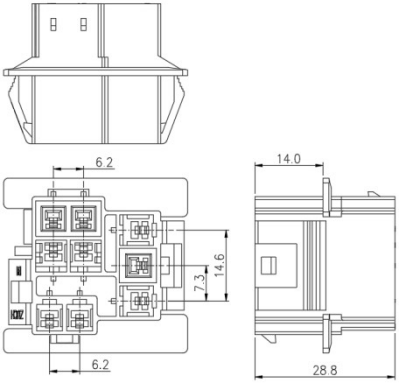
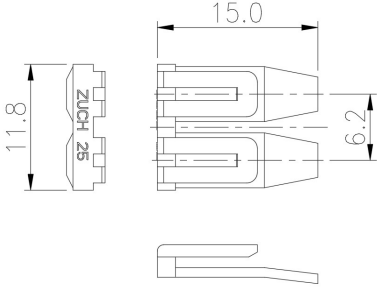
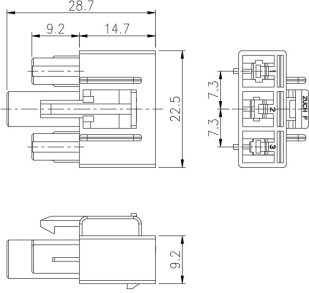
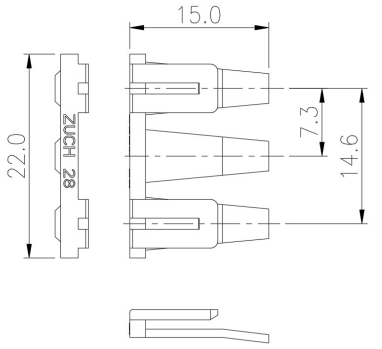
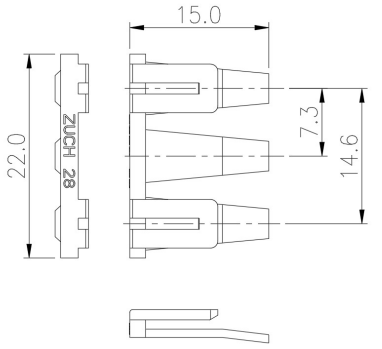
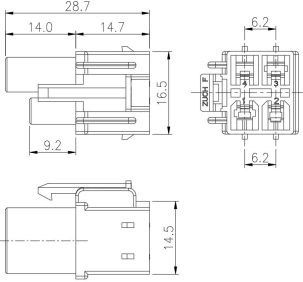
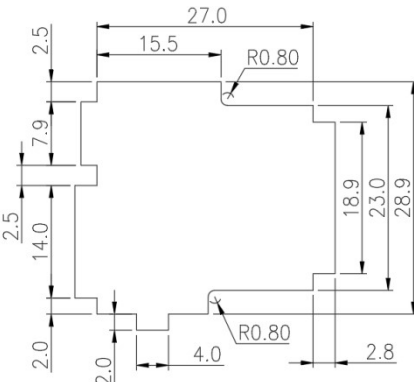
孔位 Circuits	◆ HOUSING	◆ SOCKET	◆ RETAINER
9	HP1802M-2Y (35151-0210)	HR1802M-9Y (35524-0920)	HC1802M-2S (35150-0290)
			
	HP1802M-3Y (35151-0310)		HC1802M-3S (35150-0390)
			
	HP1802M-4Y (35151-0410)		
	卡板尺寸		
 <p style="text-align: center;">卡板孔尺寸 厚度: 1.0-2.5</p>			

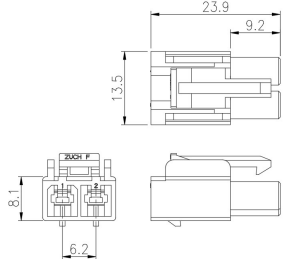
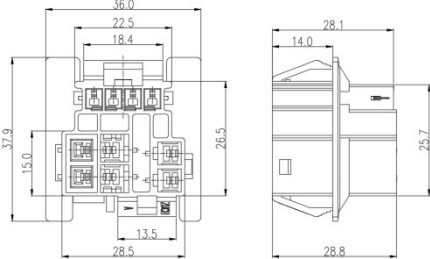
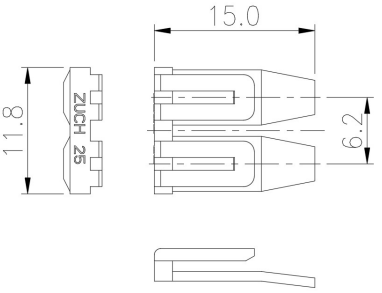
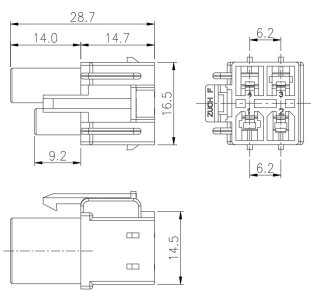
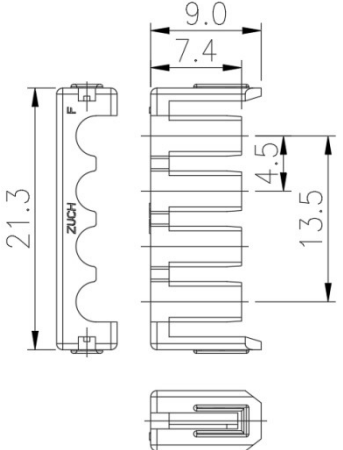
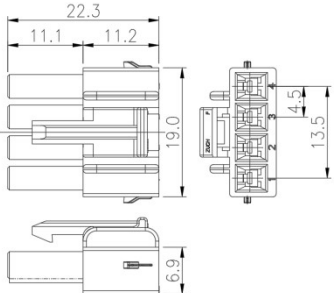
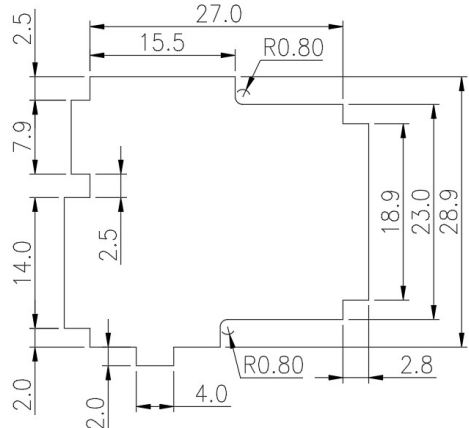
孔位 Circuits	◆ HOUSING	◆ SOCKET	◆ RETAINER
10	<p>HP1802M-2Y (35151-0210)</p> 	<p>HR1808A-10Y</p> 	<p>HC1802M-2S (35150-0290)</p> 
	<p>HP1802M-4Y (35151-0410)</p>		<p>HC4505A-4S</p>
			
	<p>HP4505A-4Y</p> 		
卡板尺寸			
			



主要技术参数 (Main specifications)

- 额定电压 (Rating Voltage): 250V AC/DC
- 额定电流 (Rating Current): 12A
- 接触电阻 (Contact Resistance): $\leq 10\text{m}\Omega$
- 绝缘电阻 (Insulation Resistance): $\geq 1000\text{M}\Omega$
- 耐压 (Withstand Voltage): 1500V AC/1min.
- 温度范围 (Temperature Range): $-25^{\circ}\text{C}\sim 85^{\circ}\text{C}$
- 孔座材料 (Housing Material): PA66
- 插座材料 (Socket Material): PA66
- 端子材料 (Terminal Material): 黄铜 Brass

孔位 Circuits	◆ HOUSING	◆ SOCKET	◆ RETAINER
2	HP1802M-2Y (35151-0210)	HR1802F-2Y	HC1802M-2S (35150-0290)
	卡板尺寸		
3	HP1802M-3Y (35151-0310)	HR1802F-3Y	HC1802M-3S (35150-0390)

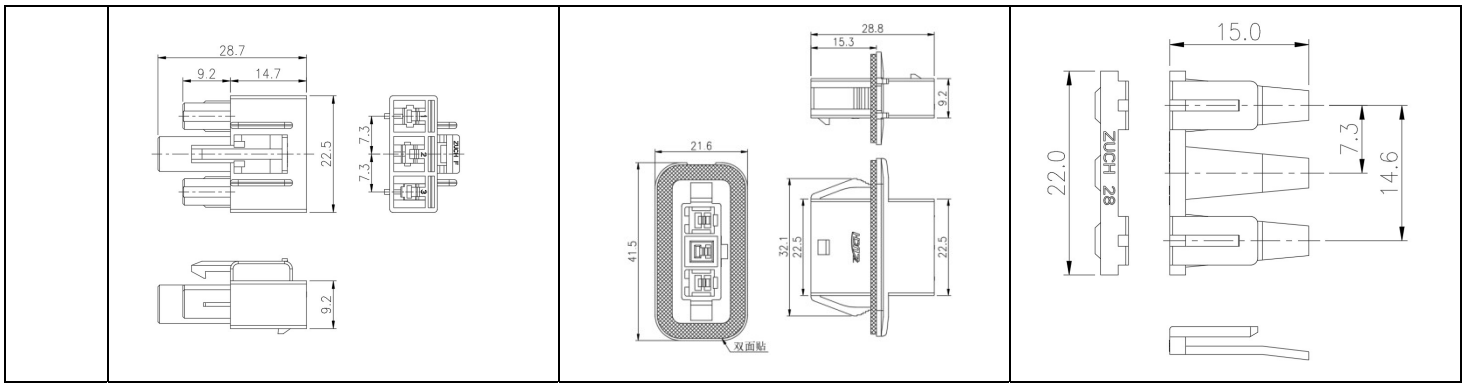

孔位 Circuits	◆ HOUSING	◆ SOCKET	◆ RETAINER
4	HP1802M-4Y (35151-0410)	HR1802F-4Y	HC1802M-2S (35150-0290)
	卡板尺寸		
4	HP18021M-2Y (35965-0210)	HR1803F-4Y	HC1803M-2S (35182-0290)
	HP18022M-2Y (35965-0200)		HC18023M-2S (35965-0290)

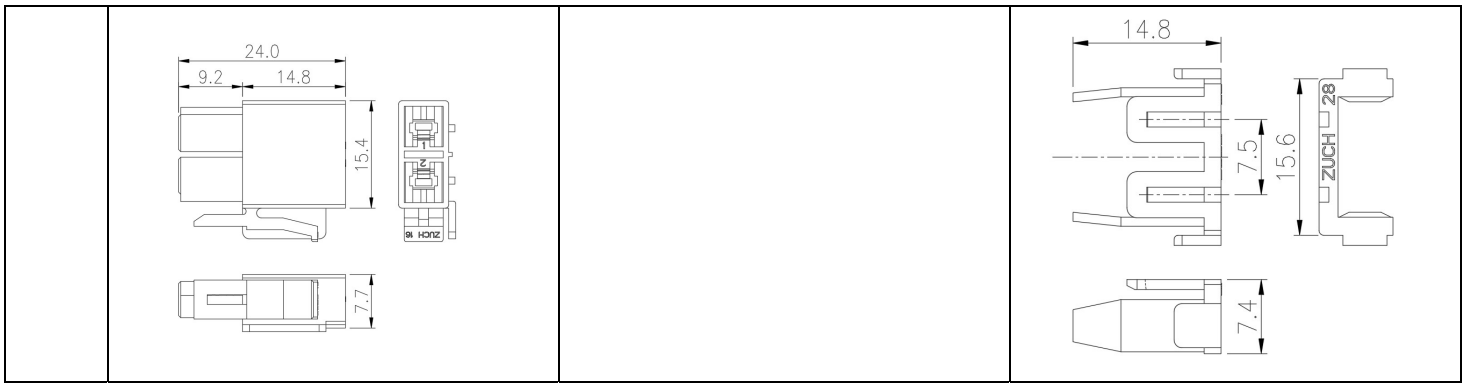

孔位 Circuits	◆ HOUSING	◆ SOCKET	◆ RETAINER	
4	HP18031M-2Y (35181-0210)	HR1803F-4Y	HC1803M-2S (35182-0290)	
	HP18032M-2Y (35181-0200)		HC1803M-1S (35182-0190)	
	卡板尺寸			

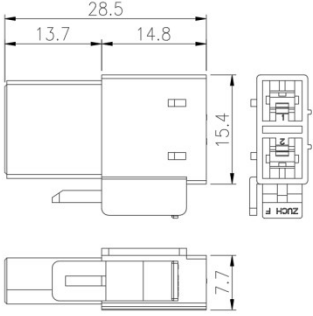
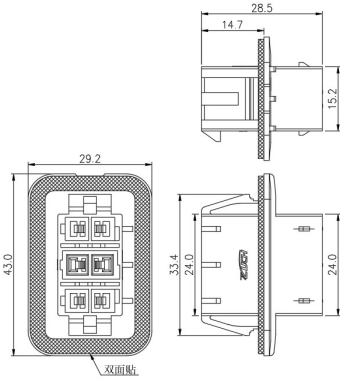
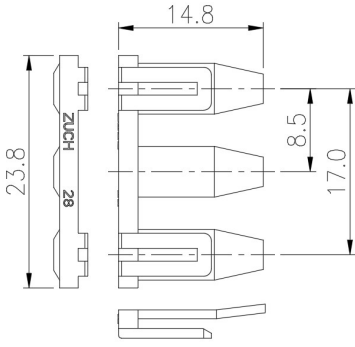
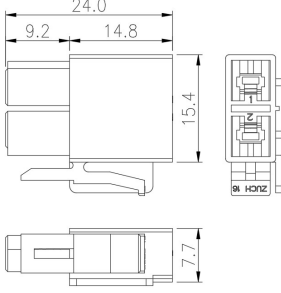
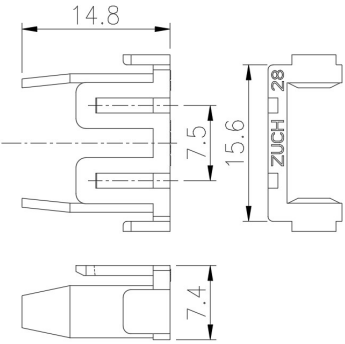
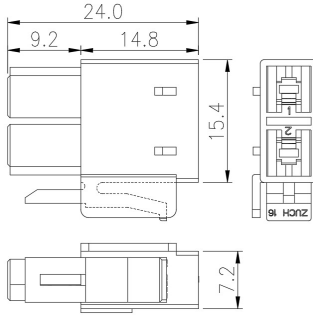
孔位 Circuits	◆ HOUSING	◆ SOCKET	◆ RETAINER
6	<p data-bbox="320 241 488 315">HP18021M-2Y (35965-0210)</p> 	<p data-bbox="788 264 930 293">HR1803F-6Y</p> 	<p data-bbox="1235 241 1390 315">HC1803M-3S (35182-0390)</p> 
	<p data-bbox="320 660 488 734">HP18022M-2Y (35965-0200)</p>		<p data-bbox="1235 810 1390 884">HC18023M-2S (35965-0290)</p>
	<p data-bbox="320 743 488 817">HP18023M-2Y (35965-0220)</p> 		
			

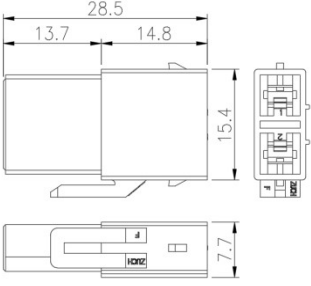
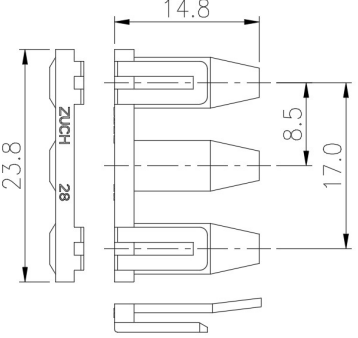
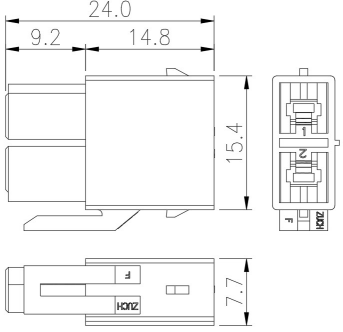
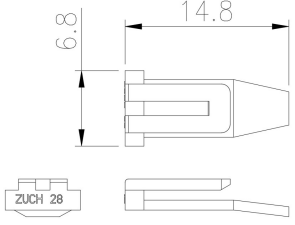
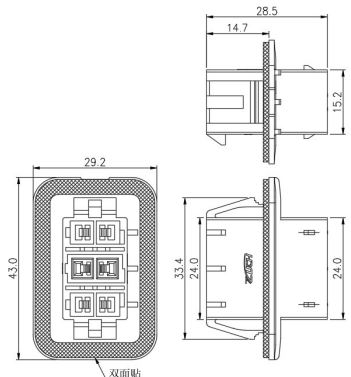
孔位 Circuits	◆ HOUSING	◆ SOCKET	◆ RETAINER
6	HP18031M-2Y (35181-0210)	HR1803F-6Y	HC1803M-3S (35182-0390)
			
	HP18032M-2Y (35181-0200)		HC1803M-1S (35182-0190)
			
	HP18033M-2Y (35181-0220)		

孔位 Circuits	◆HOUSING	◆SOCKET	◆RETAINER		
9	<p>HP1802M-2Y (35151-0210)</p>	<p>HR1802K-9Y</p>	<p>HC1802M-2S (35150-0290)</p>		
	<p>HP1802M-3Y (35151-0310)</p>		<p>HC1802M-3S (35150-0390)</p>		
	<p>HP1802M-4Y (35151-0410)</p>		<p>卡板尺寸</p>		

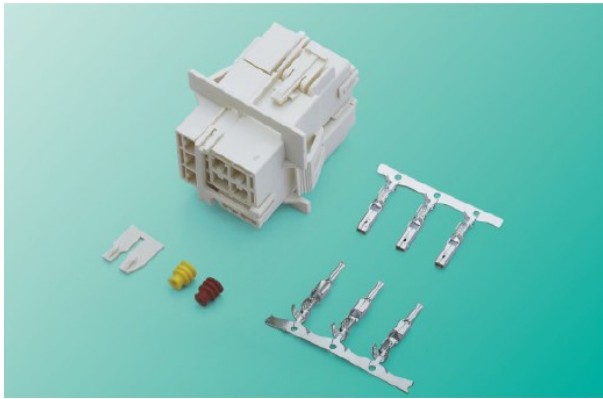

主要技术参数 (Main specifications)

- 额定电压 (Rating Voltage): 250V AC/DC
- 额定电流 (Rating Current): 12A
- 接触电阻 (Contact Resistance): $\leq 10\text{m}\Omega$
- 绝缘电阻 (Insulation Resistance): $\geq 1000\text{M}\Omega$
- 耐压 (Withstand Voltage): 1500V AC/1min.
- 温度范围 (Temperature Range): $-25^{\circ}\text{C}\sim 85^{\circ}\text{C}$
- 孔座材料 (Housing Material): PA66
- 插座材料 (Socket Material): PA66
- 端子材料 (Terminal Material): 黄铜 Brass
- 防水等级 (Waterproof Level): IP67

◆ TERMINAL

	型号 Part No.	适用电线范围 Wire Range		材质 Material	包装数量 Q'ty/reel
		mm ²	AWG#		
	TP18010G-1301	0.50~0.75	20-18	黄铜 Brass	3500PCS
	TP18010G-1303	1.50~2.50	16-14	黄铜 Brass	3500PCS
	TP18010G-1302	0.20~0.30	24-22	黄铜 Brass	3500PCS

	型号 Part No.	适用电线范围 Wire Range		材质 Material	包装数量 Q'ty/reel
		mm ²	AWG#		
	TR1805G-3 (A)	0.50~0.75	20-18	黄铜 Brass	3500PCS
	TP1801M-3 (B)	1.50~2.50	16-14	黄铜 Brass	3500PCS
	TP1801M-3 (D)	0.20~0.30	24-22	黄铜 Brass	3500PCS

◆SEALING RING

	型号 Part No.	颜色 Color	材质 Material	包装数量 Q'ty/reel
	HS18010G-2S/1201	绿色 Green	硅胶 Silica gel	1000PCS

	型号 Part No.	颜色 Color	材质 Material	包装数量 Q'ty/reel
	HS1805G-4S	绿色 Green	硅胶 Silica gel	

◆SEAL PLUG

	型号 Part No.	颜色 Color	材质 Material	适用导线 OD Applicable wire OD	备注 Remarks	包装数量 Q'ty/reel
	HS1805G-4D/0201	红色 Red	硅胶 Silica gel	Φ1.4-φ2.2	不含油 oil-free	
	HS1805G-4D/0202	红色 Red	硅胶 Silica gel	Φ1.4-φ2.2	含油 oily	
	HS1805G-4D/0701	黄色 Yellow	硅胶 Silica gel	Φ2.4-φ3.0	不含油 oil-free	
	HS1805G-4D/0702	黄色 Yellow	硅胶 Silica gel	Φ2.4-φ3.0	含油 oily	
	HS1805G-4D/0801	蓝色 Blue	硅胶 Silica gel	Φ1.6	不含油 oil-free	
	HS1805G-4D/0601	黑色 Black	硅胶 Silica gel	CQC0.75mm ²	不含油 oil-free	

孔位 Circuits	◆HOUSING	◆SOCKET	◆RETAINER
2	<p>HP18010G-2Y</p>	<p>HR18010G-2Y</p>	<p>HC18010G-2S</p>
	<p>HP1805G-4Y</p>	<p>HR1805G-4Y</p>	<p>HC1805G-4S</p>
4	<p>HP1805G-4Y</p>	<p>HR1805G-4YN</p>	<p>HC1805G-2S</p>
	卡板尺寸		

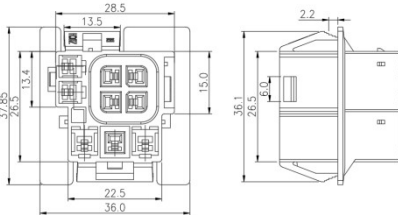
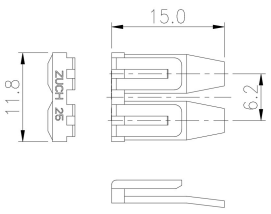
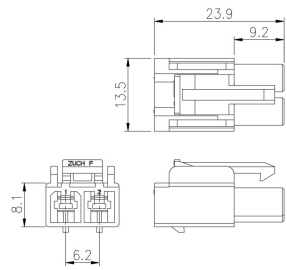
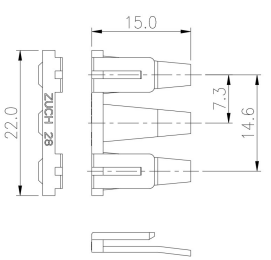
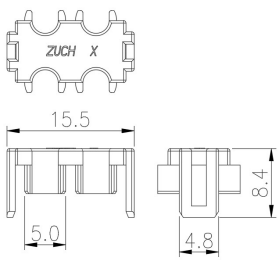
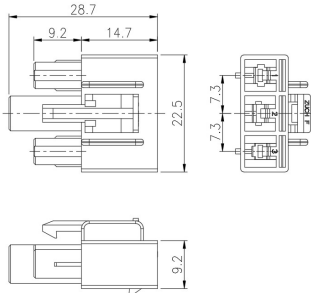
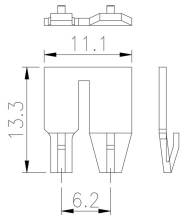
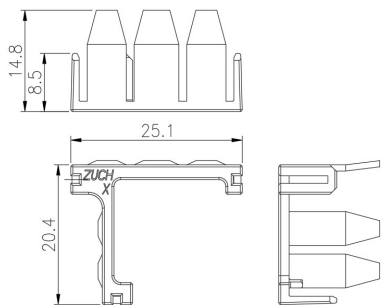
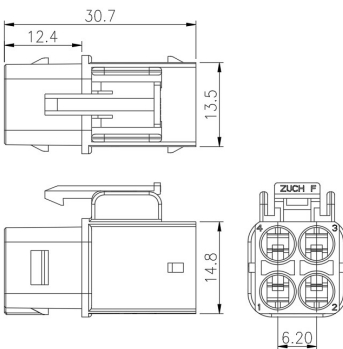
孔位 Circuits	◆ HOUSING	◆ SOCKET	◆ RETAINER
9	<p>HP1802M-2Y (35151-0210)</p>	<p>HR1805G-9Y</p> 	<p>HC1802M-2S (35150-0290)</p> 
			<p>HC1802M-3S (35150-0390)</p> 
	<p>HP1802M-3Y (35151-0310)</p>		<p>HC1805G-4S</p> 
			<p>HC1805G-2S</p> 
	<p>HP1805G-4Y</p>		<p>HC1805G-5S</p> 
			

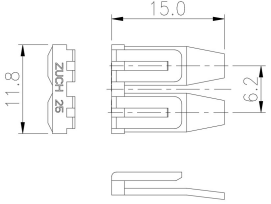
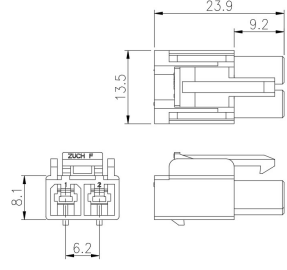
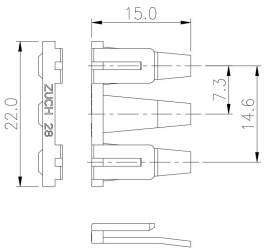
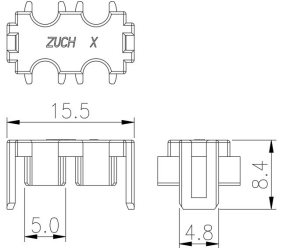
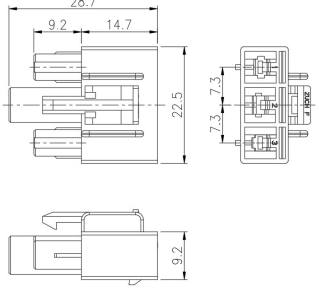
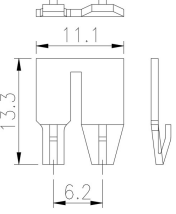
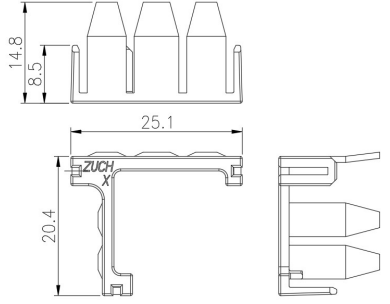
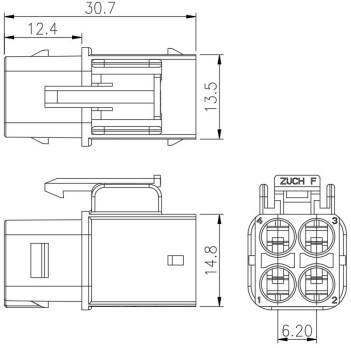
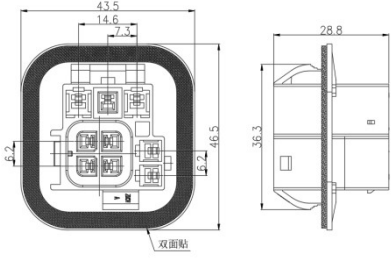
孔位 Circuits	◆ HOUSING	◆ SOCKET	◆ RETAINER
9	HP1802M-2Y (35151-0210)	HR1805F-9Y	HC1802M-2S (35150-0290) 
			HC1802M-3S (35150-0390) 
	HP1802M-3Y (35151-0310)		HC1805G-4S 
			HC1805G-2S 
	HP1805G-4Y		HC1805G-5S 
			 <p>双面粘</p>

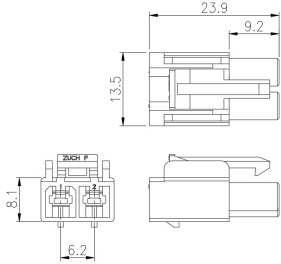
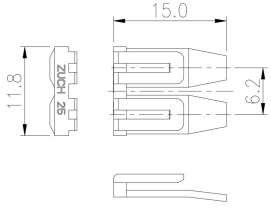
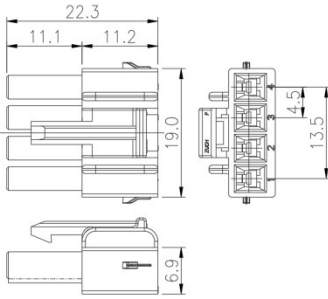
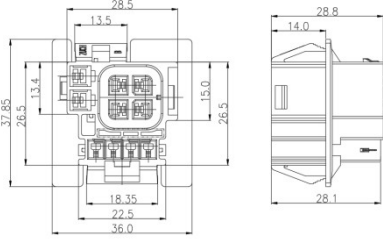
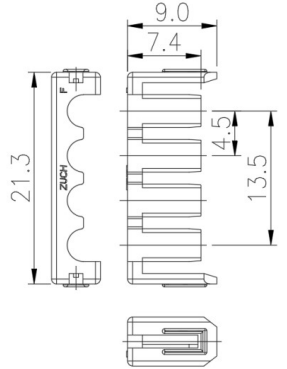
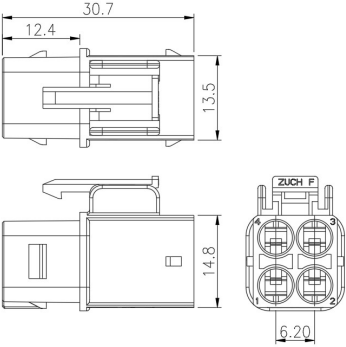
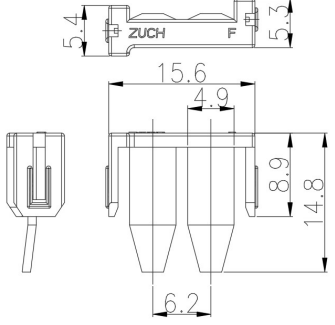
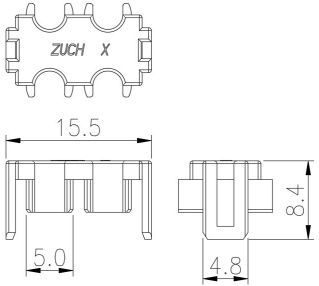
孔位 Circuits	◆ HOUSING	◆ SOCKET	◆ RETAINER
10	<p>HP1802M-2Y (35151-0210)</p> 	<p>HR1805G-10Y</p>	<p>HC1802M-2S (35150-0290)</p> 
	<p>HP4505A-4Y</p> 		<p>HC4505A-4S</p> 
	<p>HP1805G-4Y</p> 		<p>HC1805A-2S</p> 
			<p>HC1805G-4S</p> 

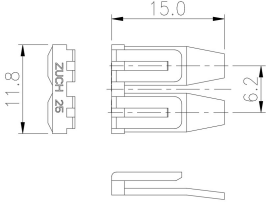
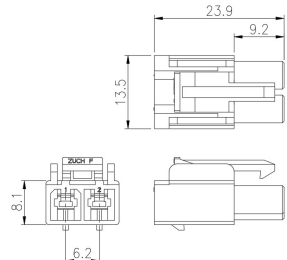
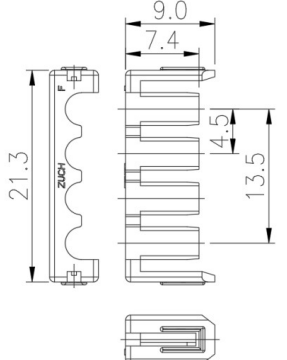
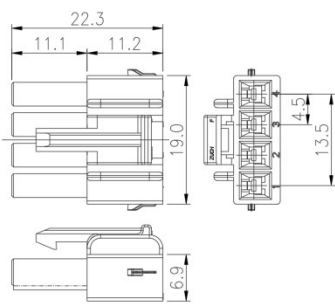
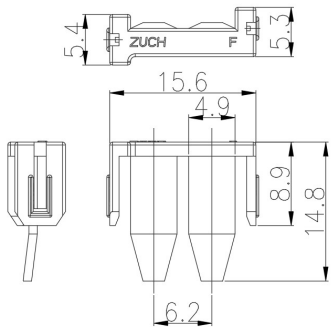
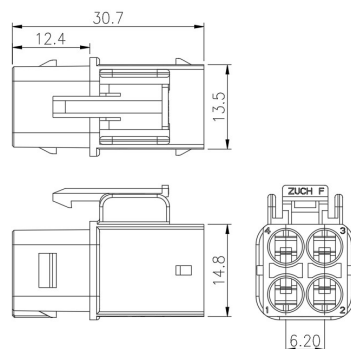
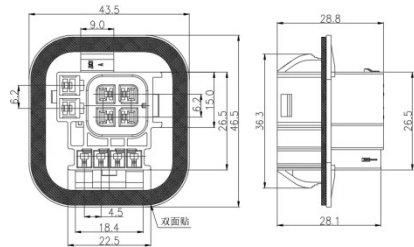
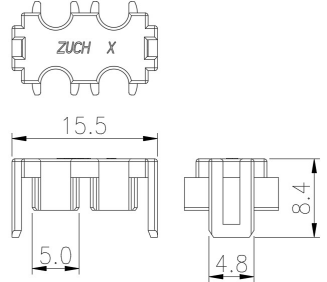
孔位 Circuits	◆ HOUSING	◆ SOCKET	◆ RETAINER
10	HP1802M-2Y (35151-0210)	HR1809F-10Y	HC1802M-2S (35150-0290) 
			HC4505A-4S
	HP4505A-4Y		
			HC1805A-2S
	HP1805G-4Y		
		HC1805G-4S 	

配合明细表

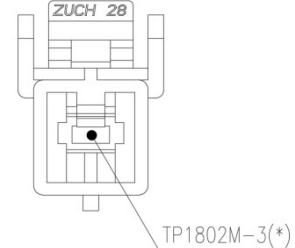
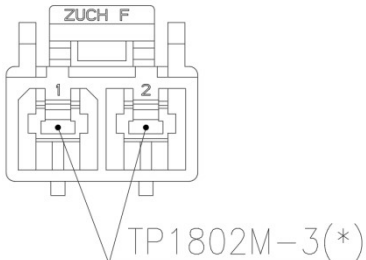
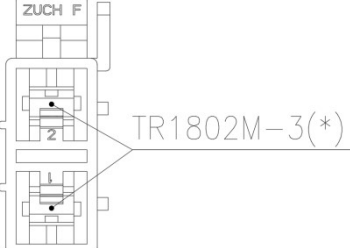
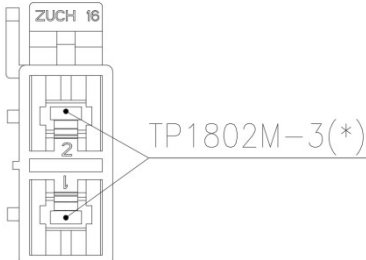
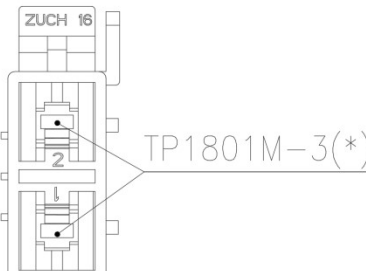
孔位 Circuits	◆ HOUSING	◆ RETAINER	◆ TERMINAL	◆ 端子装配示意图
1	HP1802M-1Y (35151-0110)	HC1803M-1S (35182-0190)	TP1802M-3(*) (35746-0*10)	
2	HP1802M-2Y (35151-0210)	HC1802M-2S (35150-0290)	TP1802M-3(*) (35746-0*10)	
2	HP18021M-2Y (35965-0210)	HC18023M-2S (35965-0290)	TR1802M-3(*) (35745-0*10)	
2	HP18022M-2Y (35965-0200)	HC18023M-2S (35965-0290)	TP1802M-3(*) (35746-0*10)	
2	HP18023M-2Y (35965-0220)	HC18023M-2S (35965-0290)	TP1801M-3(*) (35748-0*10)	

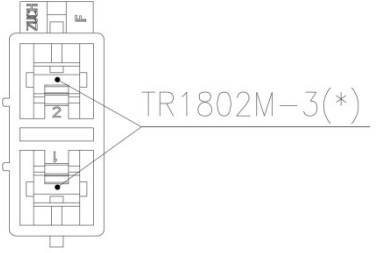
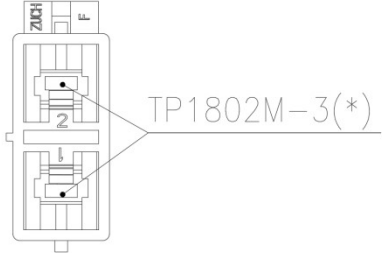
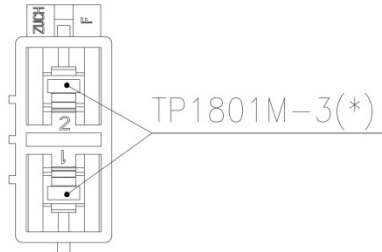
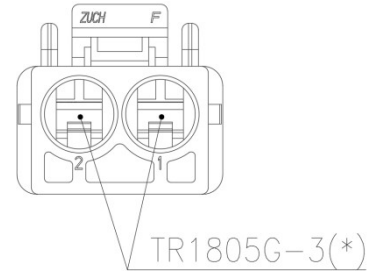
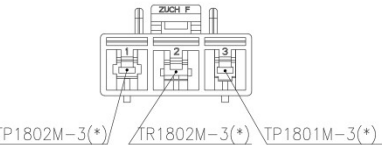
孔位 Circuits	◆ HOUSING	◆ RETAINER	◆ TERMINAL	◆ 端子装配示意图
2	HP18031M-2Y (35181-0210)	HC1803M-1S (35182-0190)	TR1802M-3(*) (35745-0*10)	
2	HP18032M-2Y (35181-0200)	HC1803M-1S (35182-0190)	TP1802M-3(*) (35746-0*10)	
2	HP18033M-2Y (35181-0220)	HC1803M-1S (35182-0190)	TP1801M-3(*) (35748-0*10)	
2	HP18010G-2Y/0101	HC18010G-2S/0101	TR1805G-3(*)	
3	HP1802M-3Y (35151-0310)	HC1802M-3S (35150-0390)	TP1802M-3(*) (35746-0*10)	
			TR1802M-3(*) (35745-0*10)	
			TP1801M-3(*) (35748-0*10)	

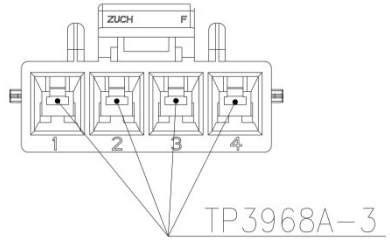
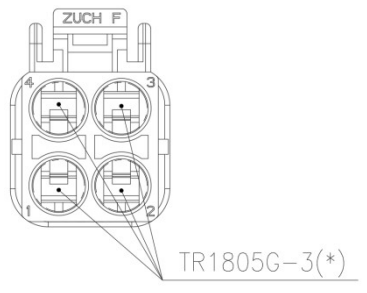
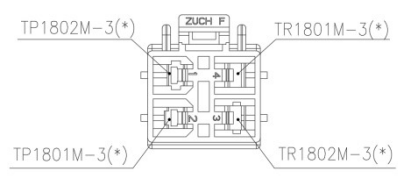
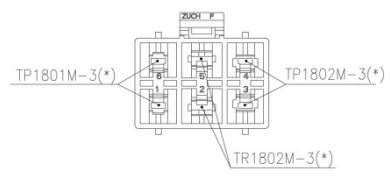
孔位 Circuits	◆ HOUSING	◆ RETAINER	◆ TERMINAL	◆ 端子装配示意图
4	HP4505A-4Y	HC4505A-4S	TP3968A-3	
4	HP1805G-4Y	HC1805G-4S	TR1805G-3(*)	
4	HP1802M-4Y (35151-0410)	HC1802M-2S (35150-0290)	TP1802M-3(*) (35746-0*10)	
			TP1801M-3(*) (35748-0*10)	
			TR1802M-3(*) (35745-0*10)	
			TR1801M-3(*) (35747-0*10)	
6	HP1802M-6Y (35151-0610)	HC1802M-3S (35150-0390)	TP1801M-3(*) (35748-0*10)	
			TR1802M-3(*) (35745-0*10)	
			TP1802M-3(*) (35746-0*10)	

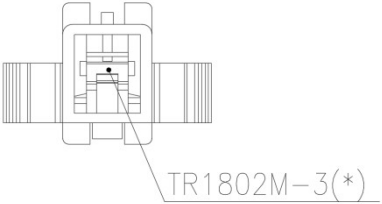
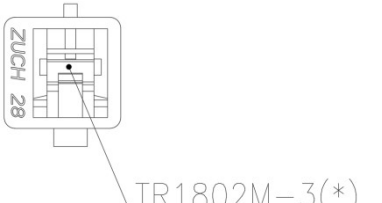
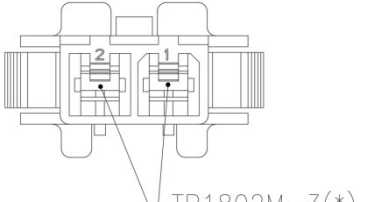
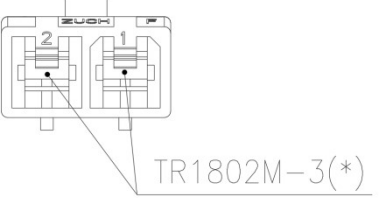
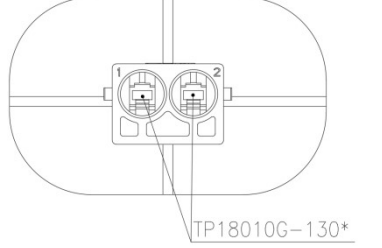
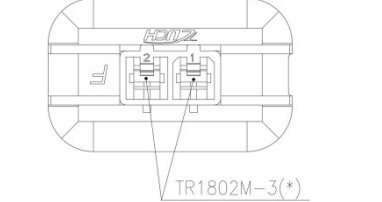
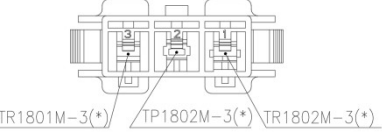
孔位 Circuits	◆SOCKET	◆RETAINER	◆TERMINAL	◆端子装配示意图
1	HR1802M-1Y (35150-0110)	HC1803M-1S (35182-0190)	TR1802M-3(*) (35745-0*10)	
1	HR1802M-1YN (35150-0100)	HC1803M-1S (35182-0190)	TR1802M-3(*) (35745-0*10)	
2	HR1802M-2Y (35150-0210)	HC1802M-2S (35150-0290)	TR1802M-3(*) (35745-0*10)	
2	HR1802M-2YN (35150-0200)	HC1802M-2S (35150-0290)	TR1802M-3(*) (35745-0*10)	
2	HR18010G-2Y/0101	HC18010G-2S/0101	TP18010G-130*	
2	HR1802F-2Y	HC1802M-2S (35150-0290)	TR1802M-3(*) (35745-0*10)	
3	HR1802M-3Y (35150-0310)	HC1802M-3S (35150-0390)	TR1801M-3(*) (35747-0*10)	
			TP1802M-3(*) (35746-0*10)	
			TR1802M-3(*) (35745-0*10)	

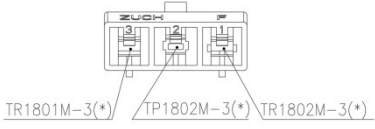
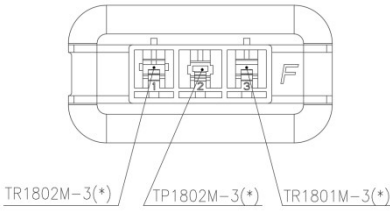
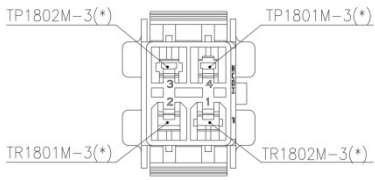
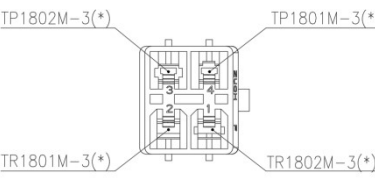
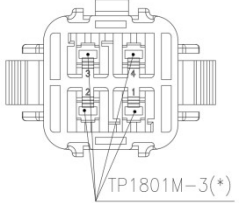
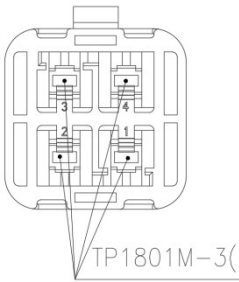
孔位 Circuits	◆SOCKET	◆RETAINER	◆TERMINAL	◆端子装配示意图
3	HR1802M-3YN (35150-0300)	HC1802M-3S (35150-0390)	TR1801M-3(*) (35747-0*10)	
			TP1802M-3(*) (35746-0*10)	
			TR1802M-3(*) (35745-0*10)	
3	HR1802F-3Y	HC1802M-3S (35150-0390)	TR1802M-3(*) (35745-0*10)	
			TP1802M-3(*) (35746-0*10)	
			TR1801M-3(*) (35747-0*10)	
4	HR1802M-4Y (35150-0410)	HC1802M-2S (35150-0290)	TR1802M-3(*) (35745-0*10)	
			TR1801M-3(*) (35747-0*10)	
			TP1802M-3(*) (35746-0*10)	
			TP1801M-3(*) (35748-0*10)	
4	HR1802M-4YN (35150-0400)	HC1802M-2S (35150-0290)	TR1802M-3(*) (35745-0*10)	
			TR1801M-3(*) (35747-0*10)	
			TP1802M-3(*) (35746-0*10)	
			TP1801M-3(*) (35748-0*10)	
4	HR1805G-4Y	HC1805G-2S	TP1801M-3(*) (35748-0*10)	
4	HR1805G-4YN	HC1805G-2S	TP1801M-3(*) (35748-0*10)	

孔位 Circuits	◆HOUSING	◆RETAINER	◆TERMINAL	◆端子装配示意图
4	HR1802F-4Y	HC1802M-2S (35150-0290)	TR1802M-3(*) (35745-0*10)	
			TR1801M-3(*) (35747-0*10)	
			TP1802M-3(*) (35746-0*10)	
			TP1801M-3(*) (35748-0*10)	
4	HR1803M-4Y (35160-0400)	HC1803M-2S (35182-0290)	TR1802M-3(*) (35745-0*10)	
			TR1801M-3(*) (35747-0*10)	
			TP1802M-3(*) (35746-0*10)	
			TP1801M-3(*) (35748-0*10)	
4	HR1803F-4Y	HC1803M-2S (35182-0290)	TR1802M-3(*) (35745-0*10)	
			TR1801M-3(*) (35747-0*10)	
			TP1802M-3(*) (35746-0*10)	
			TP1801M-3(*) (35748-0*10)	
6	HR1802M-6Y (35150-0610)	HC1802M-3S (35150-0390)	TR1801M-3(*) (35747-0*10)	
			TP1802M-3(*) (35746-0*10)	
			TR1802M-3(*) (35745-0*10)	
6	HR1803M-6Y (35180-0600)	HC1803M-2S (35182-0290)	TR1801M-3(*) (35747-0*10)	
			TP1802M-3(*) (35746-0*10)	
			TR1802M-3(*) (35745-0*10)	

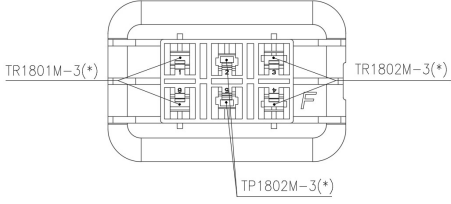
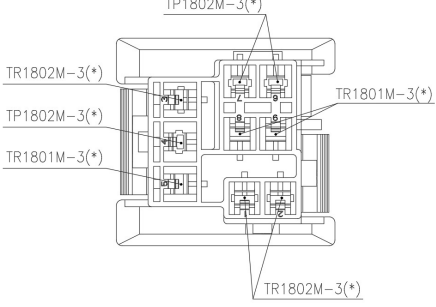
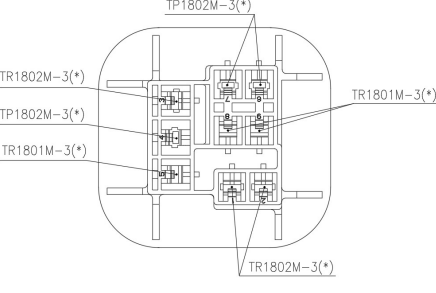
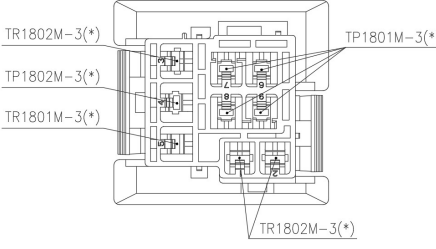
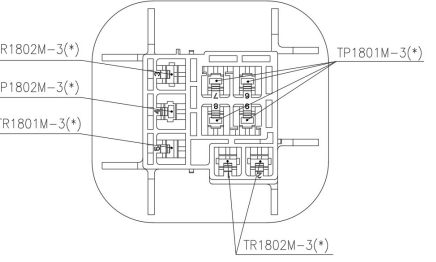
孔位 Circuits	◆HOUSING	◆RETAINER	◆TERMINAL	◆端子装配示意图
6	HR1803F-6Y	HC1803M-3S (35182-0390)	TR1801M-3(*) (35747-0*10)	
			TP1802M-3(*) (35746-0*10)	
			TR1802M-3(*) (35745-0*10)	
9	HR1802M-9Y	HC1802M-2S (35150-0290)	TR1802M-3(*) (35745-0*10)	
			TR1801M-3(*) (35747-0*10)	
		HC1802M-3S (35150-0390)	TP1802M-3(*) (35746-0*10)	
			TP1801M-3(*) (35748-0*10)	
9	HR1802K-9Y	HC1802M-2S (35150-0290)	TR1802M-3(*) (35745-0*10)	
			TR1801M-3(*) (35747-0*10)	
		HC1802M-3S (35150-0390)	TP1802M-3(*) (35746-0*10)	
			TP1801M-3(*) (35748-0*10)	
9	HR1805G-9Y	HC1802M-2S (35150-0290)	TR1802M-3(*) (35745-0*10)	
			TR1801M-3(*) (35747-0*10)	
		HC1805G-5S	TP1802M-3(*) (35746-0*10)	
			TP1801M-3(*) (35748-0*10)	
9	HR1805F-9Y	HC1802M-2S (35150-0290)	TR1802M-3(*) (35745-0*10)	
			TR1801M-3(*) (35747-0*10)	
		HC1805G-5S	TP1802M-3(*) (35746-0*10)	
			TP1801M-3(*) (35748-0*10)	

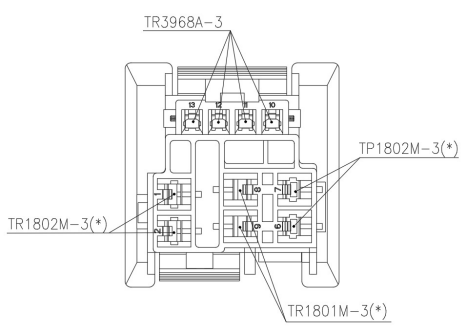
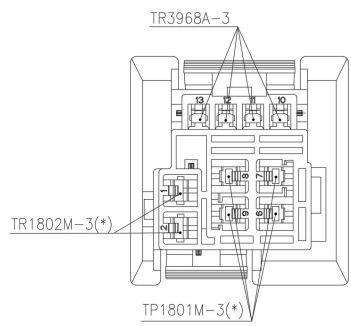
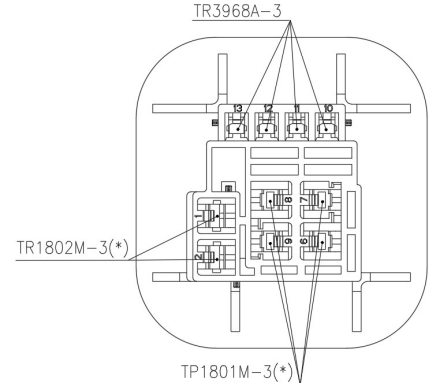
孔位 Circuits	◆HOUSING	◆RETAINER	◆TERMINAL	◆端子装配示意图
10	HR1808A-10Y	HC1802M-2S (35150-0290)	TR1802M-3(*) (35745-0*10)	
			TR1801M-3(*) (35747-0*10)	
		HC4505A-4S	TP1802M-3(*) (35746-0*10)	
			TR3968A-3	
10	HR1805G-10Y	HC1802M-2S (35150-0290)	TR1802M-3(*) (35745-0*10)	
		HC1805A-2S	TP1801M-3(*) (35748-0*10)	
		HC4505A-4S	TR3968A-3	
10	HR1809F-10Y	HC1802M-2S (35150-0290)	TR1802M-3(*) (35745-0*10)	
		HC1805A-2S	TP1801M-3(*) (35748-0*10)	
		HC4505A-4S	TR3968A-3	